

版本 REV.	日期 DATE	ECN NO.	变更内容 DESCRIPTION	制图 DRAWN

SPECIFICATIONS

- Current Rating: 1.5A AC, DC
- Voltage Rating: 150V AC, DC
- Temperatuer Range: -25°C~+85°C
- Contact Resistance: 20mΩ Max
- Insulation Resistance: 100MΩ Min
- Withstanding Voltang: 1000V AC/minute
- Material  
 Wafer: LCP UL94V-0  
 PIN: Phosphoric bronze Gold-plated  
 Solder tab: Phosphoric bronze Tin-plated

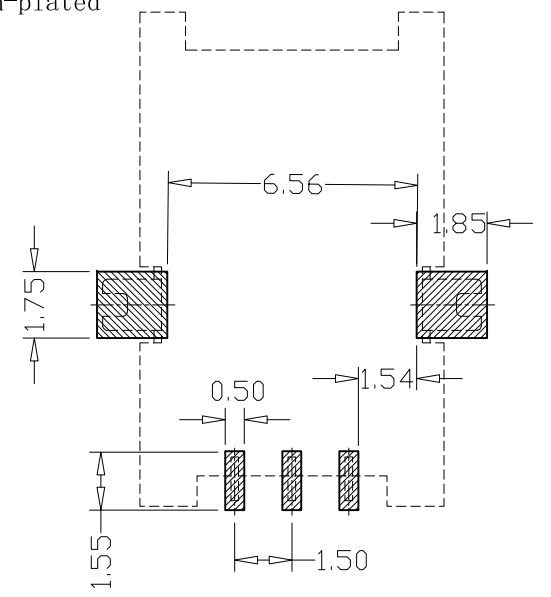
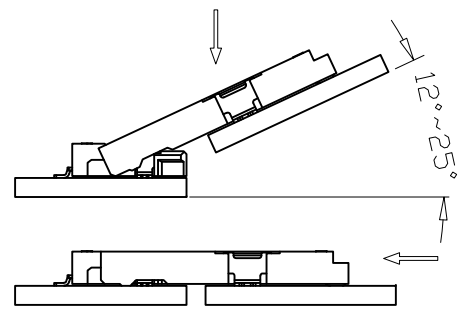
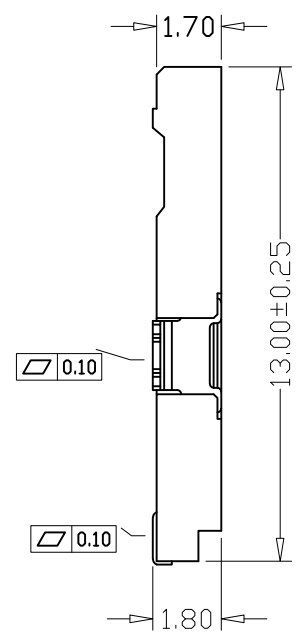
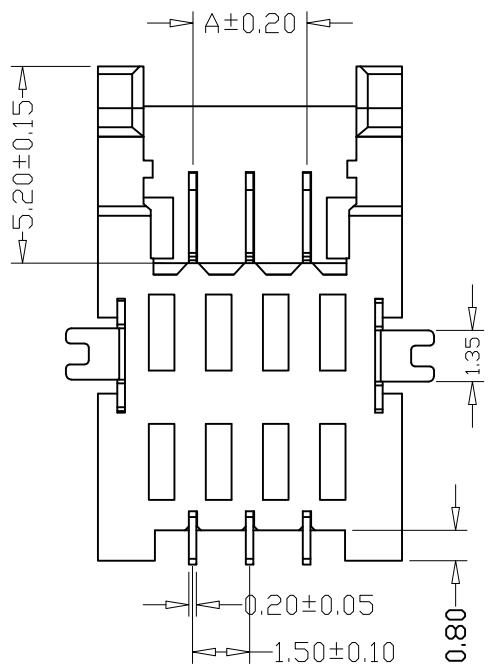
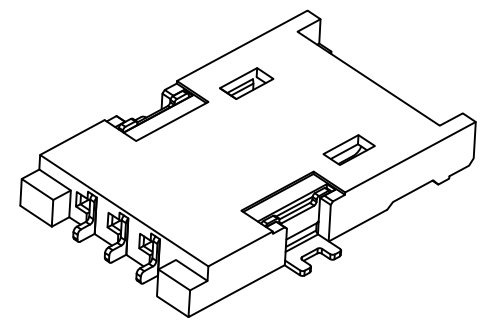
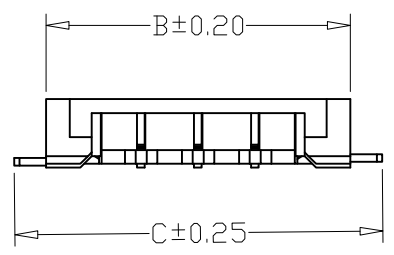

PCB LAYOUT

PIN	尺寸 (mm)		
	A	B	C
-03AWB	3.00	8.00	9.70
-05AWB	6.00	11.00	12.70
-06AWB	7.50	12.50	14.20

GENERAL TOLERANCE		制图 Mapping	张迎春 2022、09、02		料号 PART NO.	B15013-nAWB		版本 REV.	A
X±0.25	X*±2'	审核 Audit	钱岳生 2022、09、02		品名 TITLE	B1501公座 WAFER SMT TYPE		页次 SHEET	1/1
.X±0.20	.X*±1'	核准 Approved	张名 2022、09、03		客户料号 CUTM. NO.				
.XX±0.15	.XX*±0.5'	单位 Units	MM	比例 SCALE	1:1				
.XXX±0.10	.XXX*±0.5'	<b>乐清市宏一电子有限公司</b> YueQing HongYi Electronics Co., Ltd							

版本 REV.	日期 DATE	ECN NO.	变更内容 DESCRIPTION	制图 DRAWN

SPECIFICATIONS

- 1、Current Rating: 1.5A AC, DC
- 2、Voltage Rating: 150V AC, DC
- 3、Temperatuer Range: -25°C~+85°C
- 4、Contact Resistance: 20mΩ Max
- 5、Insulation Resistance: 100MΩ Min
- 6、Withstanding Voltang: 1000V AC/minute
- 7、Material  
 Wafer: LCP UL94V-0  
 PIN: Phosphoric bronze Gold-plated  
 Solder tab: Phosphoric bronze Tin-plated

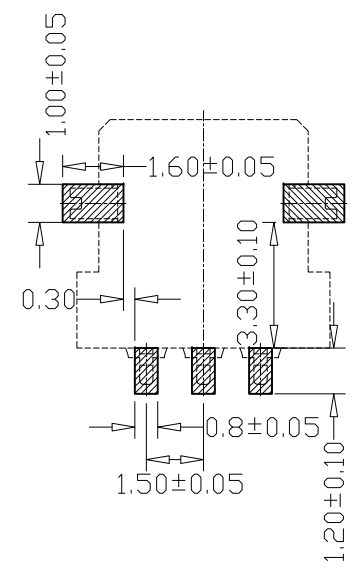
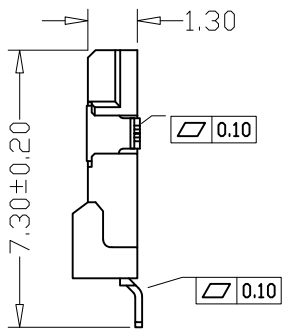
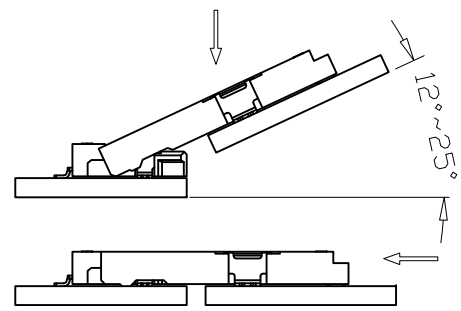
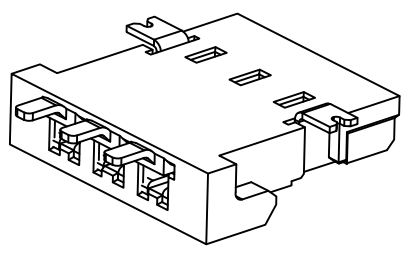
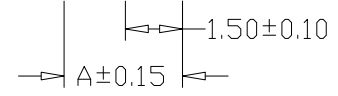
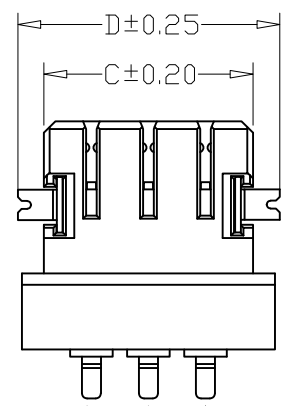
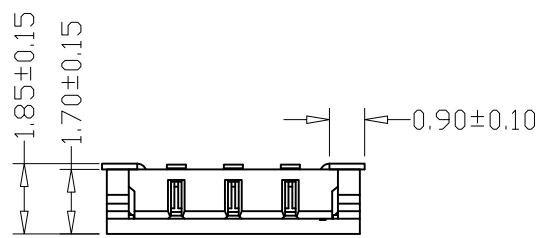
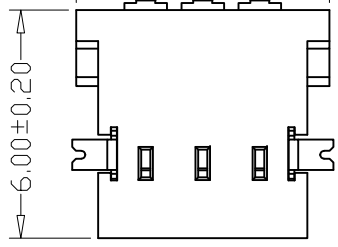
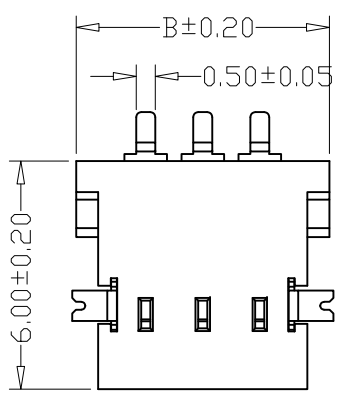

PCB LAYOUT

PIN	尺寸 (mm)			
	A	B	C	D
-03AWB	3.00	6.65	5.50	6.90
-05AWB	6.00	9.65	8.50	9.90
-06AWB	7.50	11.15	10.00	11.40

GENERAL TOLERANCE		制图 Mapping	张迎春 2022、09、02	料号 PART NO.	B15013-nAWB1	版本 REV.	A
X.±0.25	X.*±2'	审核 Audit	钱岳生 2022、09、02	品名 TITLE	B1501母座 WAFER SMT TYPE	页次 SHEET	1/1
.X±0.20	.X*±1'	核准 Approved	张名 2022、09、03	客户料号 CUTM. NO.			
.XX±0.15	.XX*±0.5'	单位 Units	MM	比例 SCALE	1:1		

乐清市宏一电子有限公司  
YueQing HongYi Electronics Co., Ltd